

DVD DVD
DVD DVD

RCA

DRC6389T

8" Dual Screen Mobile DVD

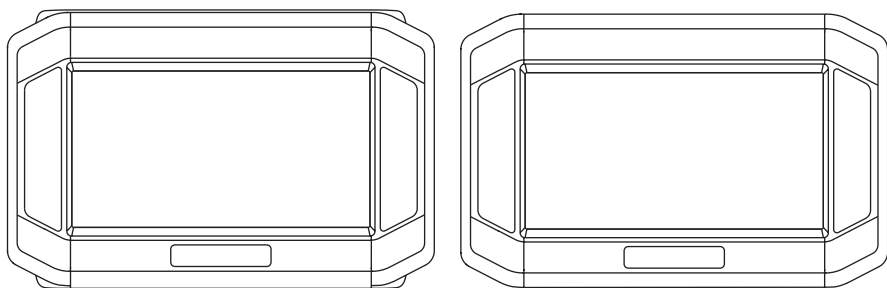



OWNER'S MANUAL

SAFETY PRECAUTIONS



 The lightning flash with an arrowhead symbol, within the equilateral triangle, is intended to alert the user to the presence of uninsulated "dangerous voltage" within the product's enclosure that may be of sufficient magnitude to cause an electric shock.

 The exclamation point within the equilateral triangle is intended to alert the user to the presence of important operating and maintenance (servicing) instructions in this owner's manual.

 **WARNING: TO REDUCE THE RISK OF ELECTRIC SHOCK, DO NOT REMOVE COVER (OR BACK). NO USER-SERVICEABLE PARTS INSIDE. REFER SERVICING TO QUALIFIED SERVICE PERSONNEL.**

 **WARNING: TO PREVENT FIRE OR SHOCK HAZARD, DO NOT EXPOSE THIS APPLIANCE TO RAIN OR MOISTURE. DO NOT PLACE OBJECTS FILLED WITH LIQUIDS ON OR NEAR THIS UNIT.**

CAUTION: USE OF CONTROLS OR ADJUSTMENTS OR PERFORMANCE OF PROCEDURES OTHER THAN THOSE SPECIFIED MAY RESULT IN HAZARDOUS RADIATION EXPOSURE.

CAUTION: DANGER OF EXPLOSION IF BATTERY IS INCORRECTLY REPLACED. REPLACE ONLY WITH THE SAME OR EQUIVALENT TYPE.

*** SEE BOTTOM OF UNIT FOR GRAPHIC SYMBOLS ***



This product contains a low power laser device.



On Placement

- Do not use this unit in places that are extremely hot, cold, dusty or humid.
- Do not restrict the airflow of this unit by placing it somewhere with poor air flow, by covering it with a cloth, or by placing it on bedding or carpeting.
- This unit should not be exposed to dripping or splashing liquid and no objects filled with liquids, such as vases, should be placed on the unit.

FCC Information

WARNING: Changes or modifications to this unit not expressly approved by the party responsible for compliance could void the user authority to operate the equipment.

NOTE: This equipment has been tested and found to comply with the limits for a Class B digital device, pursuant to Part 15 of the FCC Rules. These limits are designed to provide reasonable protection against harmful interference in a residential installation. This equipment, used in accordance with the instructions, may cause harmful interference to radio communications.

However, there is no guarantee that interference will not occur in a particular installation. If this equipment does cause harmful interference to radio or television reception, which can be determined by turning the equipment off and on, the user is encouraged to try to correct the interference by one or more of the following measures:

- Reorient or relocate the receiving antenna.
- Increase the separation between the equipment and receiver.
- Connect the equipment into an outlet on a circuit different from that to which the receiver is connected.
- Consult the dealer or an experienced radio/TV technician for help.

Shielded cables must be used with this unit to ensure compliance with the Class FCC limits.

On Safety

- When connecting or disconnecting the AC power cord, grip the plug and not the cord itself. Pulling the cord may damage it and create a hazard.
- When you are not going to use the unit for a long time, disconnect the power adapter.

On Condensation

- When left in a heated room where it is warm and damp, water droplets or condensation may form inside the unit. When there is condensation inside the unit, the unit may not function normally. Let the unit stand for 1 to 2 hours before turning the power on, or gradually heat the room and let the unit dry before use.

Rating Plate Location

- The rating plate location is on the rear of the unit.

SAFETY PRECAUTIONS



- TO PREVENT FIRE OR SHOCK HAZARD, DO NOT EXPOSE THIS UNIT TO RAIN OR MOISTURE. DO NOT PLACE OBJECTS FILLED WITH LIQUIDS ON OR NEAR THIS UNIT.
- SHOULD ANY TROUBLE OCCUR, DISCONNECT THE AC POWER ADAPTER AND REFER SERVICING TO A QUALIFIED TECHNICIAN.
- TO BE COMPLETELY DISCONNECT THE POWER INPUT, THE AC/DC ADAPTOR OF APPARATUS SHALL BE DISCONNECTED FROM THE MAINS THE AC/DC ADAPTOR OF APPARATUS SHOULD NOT BE OBSTRUCTED OR SHOULD BE EASILY ACCESSED DURING INTENDED USED.

IMPORTANT SAFETY INSTRUCTIONS

1. Read these instructions.
2. Keep these instructions.
3. Heed all warnings.
4. Follow all instructions.
5. Do not use this apparatus near water.
6. Clean only with a dry cloth.
7. Do not block any of the ventilation openings. Install in accordance with the manufacturer's instructions.
8. Do not install near any heat sources such as radiators, heat registers, stoves, or other apparatus (including amplifiers) that produce heat.
9. Do not defeat the safety purpose of the polarized or grounding - type plug. A polarized plug has two blades with one wider than the other. A grounding type plug has two blades and a third grounding prong. The wide blade or the third prong is provided for your safety. If the provided plug does not fit into your wall outlet, consult an electrician for replacement of the obsolete outlet.
10. Protect the AC power cord from being walked on or pinched particularly at plugs, convenience receptacles, and the point where they exit from the apparatus.
11. Only use attachments/accessories specified by the manufacturer.
12. Use only with a cart, stand, tripod, bracket, or table specified by the manufacturer, or sold with the apparatus. When a cart is used, use caution when moving the cart/apparatus combination to avoid injury from tip-over.



13. Unplug this apparatus during lightning storms or when unused for long periods of time.
14. Refer all servicing to qualified service personnel. Servicing is required when the apparatus has been damaged in any way, such as the power-supply cord or plug is damaged, liquid has spilled or objects have fallen into the apparatus, the apparatus has been exposed to rain or moisture, does not operate normally, or has been dropped.

TABLE OF CONTENTS

Safety Precautions	1	Locating a Desired Section.....	19
Important Safety Instructions.....	2	Locating a Specific Title.....	19
Table of Contents.....	3	Locating a Specific Chapter.....	19
Disc Formats	4	Locating a Specific Time.....	19
Accessories	5	DVD Programmable memory.....	20
Remote Control	5	Playing Titles/Chapters in a Favourite Order	20
Control Reference Guide.....	6-8	Repeat playback.....	20
Remote Control.....	6	Repeating a Chapter/Title.....	20
DVD Player	7	Repeating a Single Track/Whole Disc.....	20
Monitor.....	8	Repeating a Specific Section.....	20
Power Supply.....	9-11	Viewing JPG Files	21
Using the Car Power Adaptor	9	Play Modes for CD or JPG Disc	21
Using the AC Power Adaptor	10	Customizing the Function Settings.....	22-23
Using the Built-in Battery	11	Language Setup	22
Connections.....	12-14	Video Setup	23
Watching a DVD on the Main Unit and the		Misc Setup.....	24
Monitor.....	12	Maintenance	24
Connecting a TV	12	Cleaning the Disc.....	24
Connecting a Stereo Receiver or Amplifier.....	13	Cleaning the Unit	24
Connecting to a Video Equipment	13	Important Note	24
Connecting Game Systems/Video Equipment.....	13	Troubleshooting Guide.....	25
Using the Monitor with Other Equipment while			
Playing DVD on the Main Unit.....	14		
Using Headphones/Earphones.....	14		
Mounting in the Vehicle.....	15		
Using the Stand for Desktop Use	16		
Sound System	16		
Unit Operation	16		
Playing a Disc.....	17-18		
Playing a Disc.....	17		
Pausing Playback (Still Mode)	17		
Stopping Playback.....	17		
Fast Forward / Fast Reverse	17		
Skip (Forward / Reverse)	17		
Audio Selection.....	17		
Subtitle Selection.....	18		
Angle Selection.....	18		
Display Function	18		
Adjust the LCD Screen	18		

DISC FORMATS

The unit can playback discs bearing any of the following marks:



DVDs
[8cm(3")/12cm(5") disc]



Audio CDs
[8cm(3")/12cm(5") disc]

CD-R CD-RW
Compatible

Region Management Information

Region Management Information: This unit is designed and manufactured to respond to the Region Management Information that is encoded on DVDs. If the region number printed on the DVD does not correspond to the region number of this unit, this unit cannot play that disc.

The region number of this unit is 1. 

Disc Function or Operation that is Not Available

When the  symbol appears on the TV screen, it indicates that the function or operation attempted is not available at that time. This occurs because the DVD manufacturer determines the specific functions. Certain functions may not be available on some discs. Be sure to read the documentation provided with the disc.

Icons Used on DVDs

Sample Icons

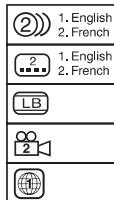

- Language selections for audio
- Language selections for subtitles
- Screen aspect ratio
- Multiple camera angles
- Region code indicator

Note:

- When playing back a CD-G (Graphics) or CD EXTRA disc, the audio portion will be played, but the graphic images will not be shown.

Titles, Chapters and Tracks

- DVDs are divided into "titles" and "chapters". If the disc has more than one movie on it, each movie would be a separate "title". "Chapters" are sections of titles.
- Audio CDs are divided into "tracks". A "track" is usually one song on an Audio CD.

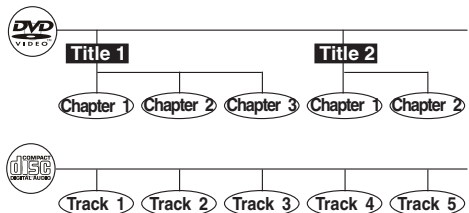

Note:

- Numbers identify each title, chapter, and track on a disc. Most discs have these numbers recorded on them, but some do not.

Notes on Unauthorized Discs

You may not be able to play back some DVDs on this unit if they were purchased from outside your geographic area or made for business purposes.

ACCESSORIES

Please check and identify the supplied accessories.

- Remote Control (with battery)x 1
- Car Power Adapterx 1
- AC Power Adapterx 1
- DC-AV Cablex 1
- Mounting Strapx 2

REMOTE CONTROL

Using the Remote Control

- Point the remote control at the REMOTE SENSOR located on the unit.
- When there is a strong ambient light source, the performance of the infrared REMOTE SENSOR may be degraded, causing unreliable operation.
- The recommended effective distance for remote operation is about 16 feet (5 meters).

Take out the plastic sheet before operating the Remote Control.

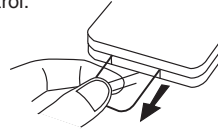

To Change Remote Battery

1. Open the battery door.

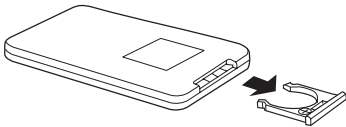

2. Insert one CR2025 (3V) size battery.

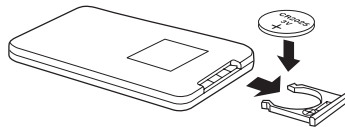

BATTERY REPLACEMENT

When battery becomes weak, the operating distance of the remote control will be greatly reduced and you will need to replace the battery.

Note:

- If the remote control is not going to be used for a long time, remove the battery to avoid damage caused by battery leakage corrosion.
- When discarding batteries, environmental problems must be considered and local rules or laws governing the disposal of these batteries must be strictly followed.

WARNING:

- Do not dispose of battery in fire, battery may explode or leak.
- The battery should not be exposed to excessive heat such as sunshine, fire or the like.

CAUTION:

Danger of explosion if battery is incorrectly replaced. Replace only with the same or equivalent type.

CONTROL REFERENCE GUIDE

DVD Player

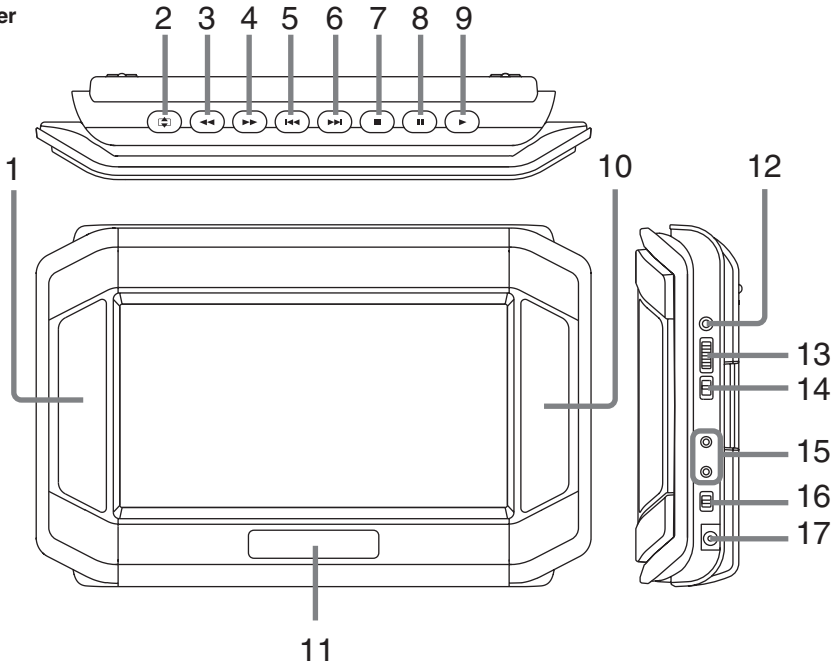

- 1) **Left Speaker**
- 2) **SCREEN ROTATE Button**
Flips the screen 180°.
- 3) **SEARCH Button**
Performs fast reverse playback.
- 4) **SEARCH Button**
Performs fast forward playback.
- 5) **PREV Button**
Goes backwards to previous chapters/tracks.
- 6) **NEXT Button**
Advances chapters/tracks.
- 7) **STOP Button**
Stops playing a disc.
- 8) **PAUSE Button**
Pauses playback and frame advance.
- 9) **PLAY Button**
Starts or resumes playback of a disc.

- 10) **Right Speaker**
- 11) **"ON" Indicator**
When the CHARGE / STANDBY / ON switch is in the ON position, the green light will illuminate.
Indicator
When the CHARGE / STANDBY / ON switch is in the CHARGE position, the red light will illuminate.
Remote Sensor
Receives the remote control signal.
- 12) **Headphone Jack**
- 13) **VOLUME Control**
Adjusts the volume.
- 14) **CHARGE / STANDBY / ON Switch**
- 15) **AUDIO IN / OUT and VIDEO IN/OUT Jacks**
- 16) **DVD / AV IN Switch**
- 17) **DC IN 9V-12V Jack**

CONTROL REFERENCE GUIDE

Monitor

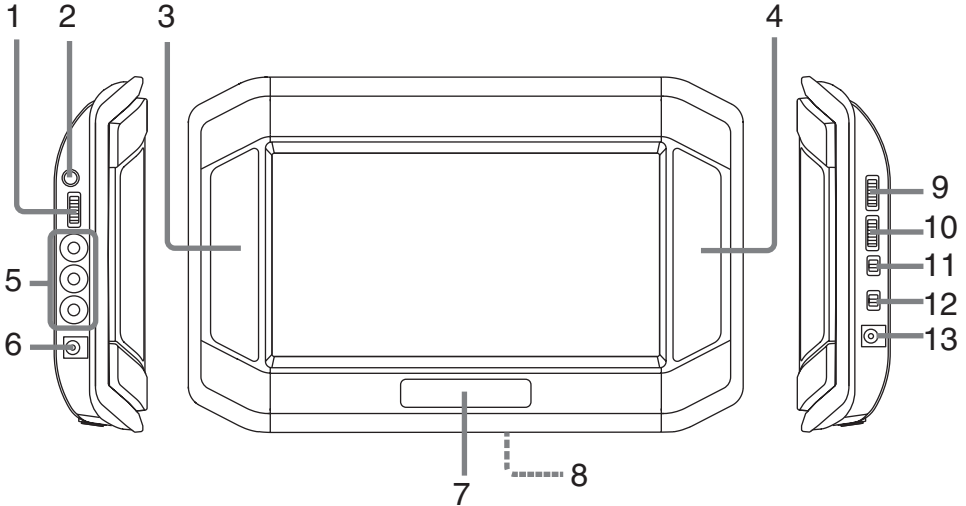

- 1) **VOLUME Control**
Adjusts the volume.
- 2) **Headphone Jack**
- 3) **Left Speaker**
- 4) **Right Speaker**
- 5) **AUDIO / VIDEO IN Jacks**
- 6) **DC OUT 9-12V Jack**
- 7) **POWER ON Indicator**
When the STANDBY / ON switch is in the ON position, the green light will illuminate.
- 8) **Stand**
- 9) **BRIGHTNESS Control**
Adjusts the relative lightness or darkness of the screen.
- 10) **COLOR Control**
Adjusts the color intensity.
- 11) **Screen Switch**
WIDE: Wide Screen
NORMAL: Pan Screen
- 12) **ON / OFF Switch**
- 13) **DC IN 9-12V Jack**

POWER SUPPLY

A. Using the Car Power Adapter

The included 12V car power adapter is designed for use with vehicles that have a 12V, negative ground electrical system.

Using the Main Unit and the Monitor together

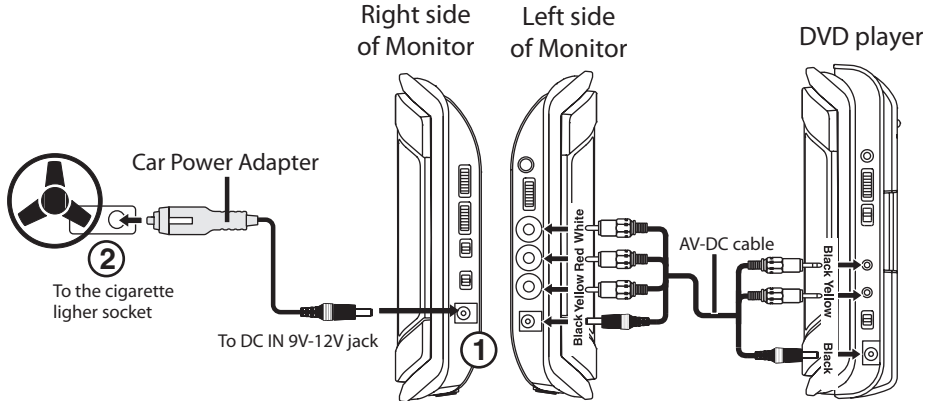

Using the Main Unit or the Monitor separately

DVD player

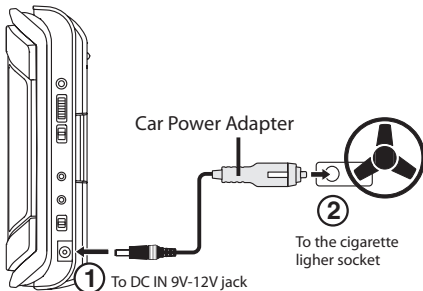

Right side of Monitor

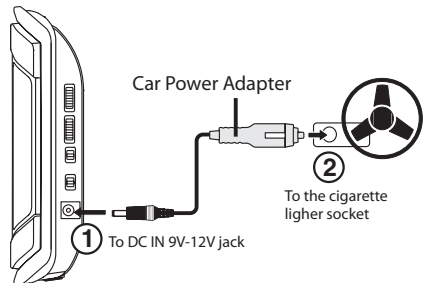

IMPORTANT

This car adapter is for use with 12 volt batteries only.

WARNING:

Disconnect this car power adapter when not in use. Not for use in 24V vehicles.



Cautions:

- Use this unit only with the included 12V car power adapter. Use with other car adapters could damage the unit, or even your vehicle.
- The included 12V car power adapter is for use with this unit only. Do not use it with any other equipment.
- In the interest of traffic safety, drivers should not operate the unit or view videos while driving.
- When the inside of the 12V car socket is dirty with ashes or dust, the plug section may become hot due to poor contact. Be sure to clean the 12V car socket before use.
- After use, disconnect the 12V car power adapter from both the unit and cigarette lighter socket.
- If the unit is not properly attached to a vehicle, it may become airborne in the event of an accident and cause damage, injury, or death.
- Check your local traffic laws for rules governing the use of video devices in vehicles.

POWER SUPPLY

B. Using the AC Power Adapter

The included AC power adapter operates on AC between 100V and 240V.

- The supplied AC adapter is suitable for use on AC mains supplies of 100-240 Volts AC and should only be connected to a mains supply within these parameters.

Using the Main Unit and the Monitor together

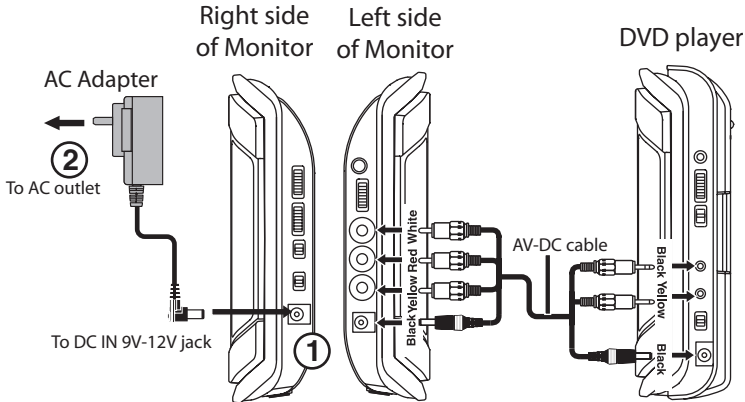

Using the Main Unit or the Monitor separately

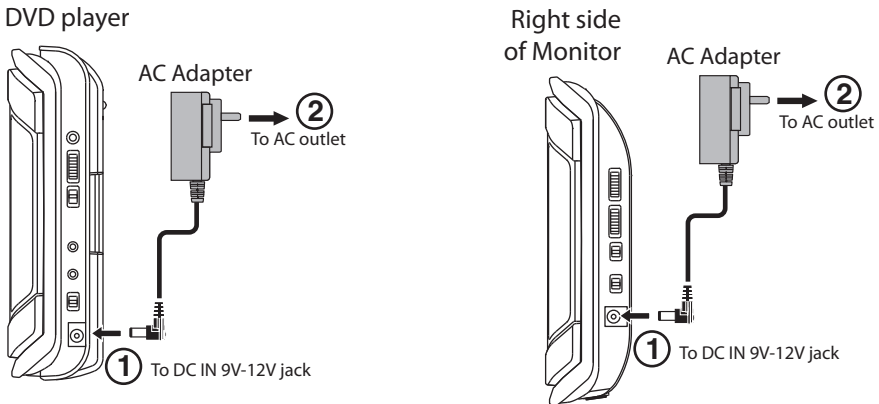

Cautions:

- The AC adapter included with this unit is for its use only. Do not use it with other equipment.
- Turn off the unit before unplugging the AC adapter from the unit so as to avoid the unit being damaged.
- When the unit is not going to be used for long time, disconnect the AC adapter from the wall outlet.

IMPORTANT

- Be sure to use it near an easily accessible wall outlet. If a malfunction occurs, disconnect the plug from the wall outlet at once.
- When the AC adapter is plugged in, the apparatus is not completely disconnected from the main power source, even when the unit is turned off.

C. Using the Built-in Battery

The unit has a built-in, non-replaceable, rechargeable battery. Charge the built-in battery before using it for the first time. The normal charging time should be completed within 3-4 hours. The red charging light will go out when the built-in battery becomes fully charged.

To Recharge the Built-in Battery

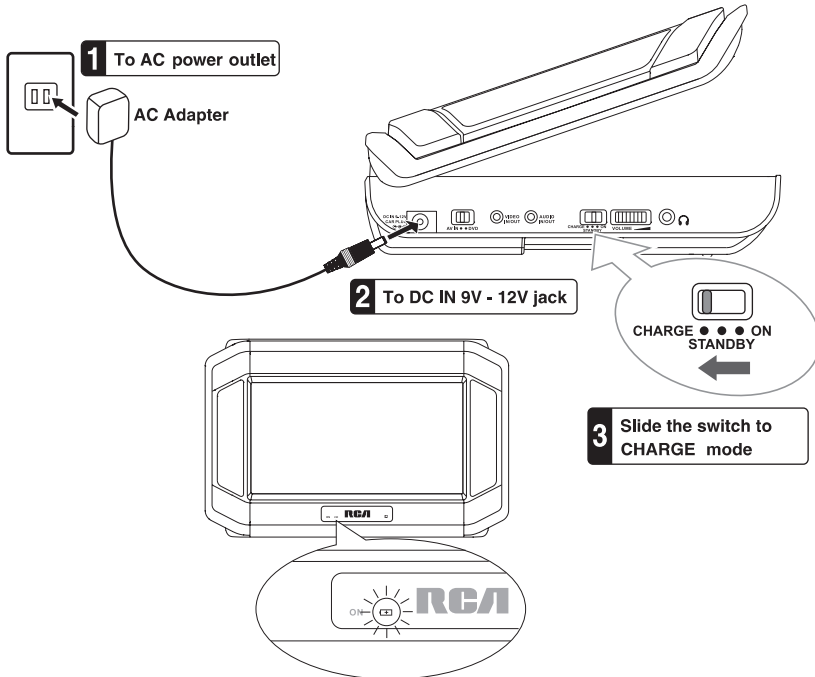

WARNING

- The built-in battery should not be exposed to excessive heat such as sunshine, fire or the like.
- The built-in battery presents a risk of fire or chemical burn if mistreated. Do not disassemble, place near a source 212°F (100°C), or incinerate.
- Dispose the unit with built-in battery properly. Environmental problems must be considered and local rules or laws governing the disposal must be strictly followed.

CAUTION

- The built-in battery can only be recharged when the unit is in CHARGE mode while using the AC adapter.
- The built-in battery cannot be recharged when the unit is in power ON mode.
- Do not recharge the battery in the vehicle by using the car power adapter.
- When the built-in battery power is low, "BATTERY LOW" will appear on the screen and the unit will stop playing.
- Recharge the built-in battery when you are ready to use it again.
- While using the built-in battery, the environmental temperature should be 41°F (5°C) to 95°F (35°C).
- To get the longest service life of the built-in battery, charge at indoor temperature.

CONNECTIONS

A. Watching a DVD on the Main Unit and the Monitor

You can watch the same DVD on the main unit and the monitor.

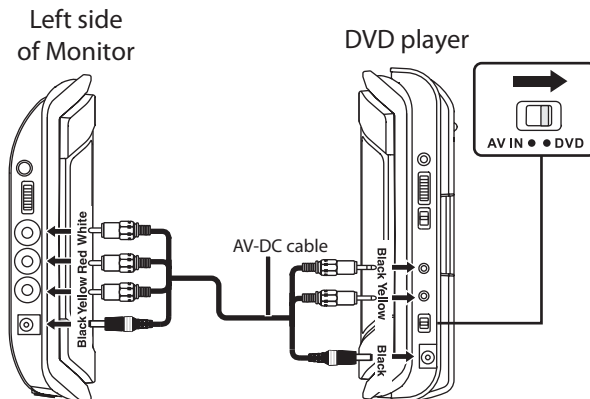

Watching a DVD on the Main Unit and the Monitor

1. Connect the main unit and the monitor using the included DC-AV Cable.
2. Slide the **AV IN / DVD** switch to the DVD position.
3. Turn on the main unit and the monitor.
4. Play a DVD on the main unit; the monitor will play at the same time.

Note: You can also use the included AC power adapter to supply power.

B. Connecting a TV (for the Main Unit Only)

If your TV has Audio/Video inputs, you can connect the main unit to your TV using a standard A/V cable (not included).

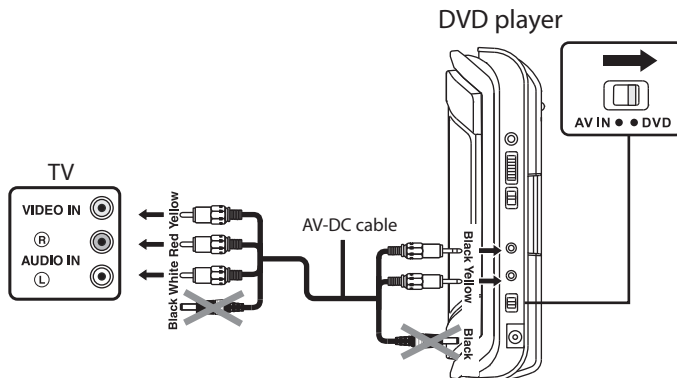

Watching a DVD on your TV

1. Connect your TV to the main unit using a standard AV Cable (not included).
2. Turn on the main unit and slide the **AV IN / DVD** switch to the DVD position.
3. Turn on the TV and follow the instructions included with it to play the DVD.

Notes:

- Make sure to use the correct Audio/Video cable. Connecting the plugs incorrectly may cause a weak signal.
- If your TV does not have Audio/Video inputs, you will need to purchase an RF modulator (sold separately) and follow the instructions included with it to connect the unit to your TV.

CONNECTIONS

C. Connecting a Stereo Receiver or Amplifier (for the Main Unit Only)

The main unit can play two channels Dolby Digital.

Listening on External Audio Equipment

1. Connect the main unit to the left / right Audio In jacks on the other equipment using a standard Audio cable (not included).
2. Turn on the main unit and slide the **AV IN / DVD** switch to the DVD position.
3. Turn on your audio equipment and follow the instructions provided with it to select the AUDIO IN function.

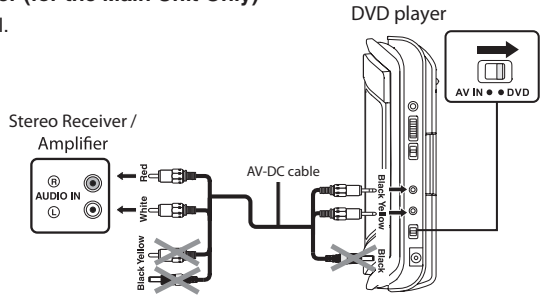

Notes:

- Make sure to use the correct Audio cable. Connecting the plugs incorrectly may cause a weak signal.
- If you have a stereo VCR, make sure you set it to stereo mode.
- Due to copyright protection, DVD movies cannot be copied. If you copy a DVD movie onto a videotape, the resulting copy will be unclear, with poor sound quality. This is NOT caused by a defective DVD system.

D. Connecting to a video equipment (for the Main Unit only)

You can connect other video equipment for playback through the unit.

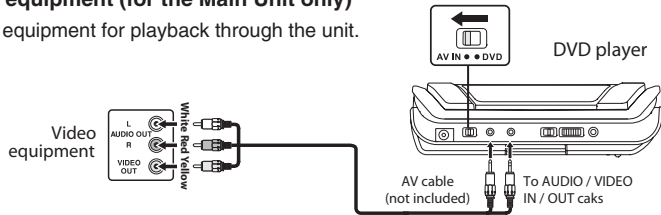

Watching video equipment

1. Turn on the unit and slide the **AV IN / DVD** switch to the AV IN position.
2. Turn on the video equipment and follow the instructions provided with it to playback.

E. Connecting Game Systems/Video Equipment (for the Monitor Only)

You can connect game systems or other video equipment for playback through the monitor.

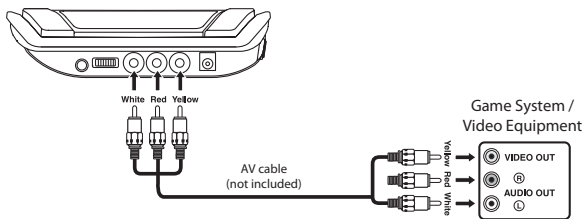

Watching video equipment

1. Connect the other equipment to the monitor using a standard AV Cable (not included).
2. Turn on the monitor.
3. Turn on the video equipment and follow the instructions provided with it to playback.

Notes:

- Make sure to use the correct Audio/Video cable. Connecting the plugs incorrectly may cause a weak signal.
- If you have a mono VCR, the volume level from the speakers will be low.

CONNECTIONS

F. Using the Monitor with Other Equipment while Playing DVD on the Main Unit

You can use a game console or other video equipment on the monitor while playing a DVD on the main unit.

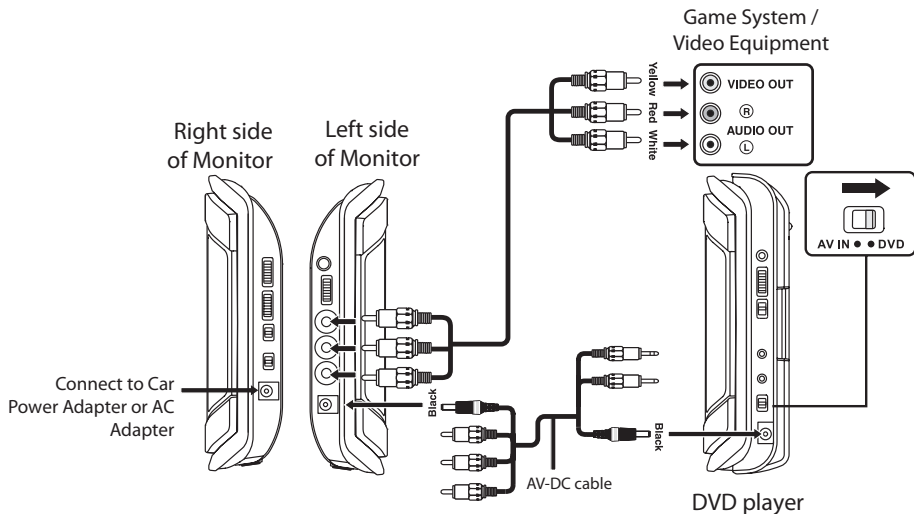

Watching Video Equipment on the Monitor while Playing DVD on the Main Unit

1. Connect only the power connector between the main unit and the monitor. Do not connect the Audio/Video portion of the DC-AV cable.
2. Connect the monitor to the other equipment using a standard AV cable (not included).
3. Turn on the main unit, the monitor and the other equipment.
4. Slide the **AV IN / DVD** switch to the DVD position.
5. Play a DVD on the main unit.
6. Use the monitor for the other equipment.

Notes:

- You can also use the included AC power adapter to supply power.
- Make sure to use the correct Audio/Video cable. Connecting the plugs incorrectly may cause a weak signal.
- If you have a mono VCR, the volume level from the speakers will be low.

G. Using Headphones/Earphones

Turn down the volume before connecting the headphones/earphones. Slowly raise the volume with the headphones on until you reach your desired volume. When headphones are connected, the speaker is automatically disabled.

Caution:

- Avoid listening to sound at excessive levels which could be harmful to your ears.

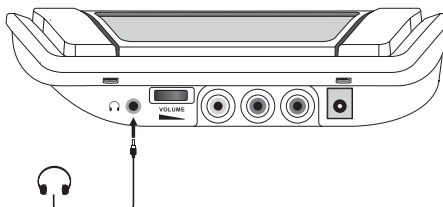
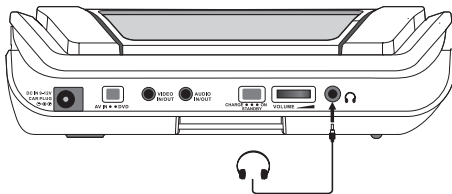

MOUNTING IN THE VEHICLE

Mounting in the Vehicle

Use the supplied mounting straps to install the main unit and monitor on the back of the vehicle's headrests. Tightly wrap the mounting strap around the headrest.

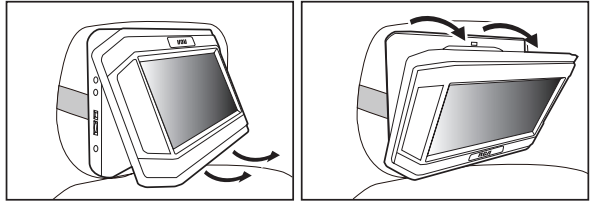
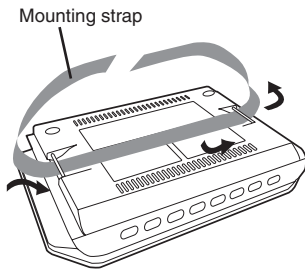

Adjusting viewing angle

SAFETY WARNING!

- This unit should never be used by the vehicle's driver or left unsecured in the vehicle while driving.
- If this unit is being used in your vehicle, be sure that it is secured or held safely, and does not obstruct any safety device, including air bags or seat belts.
- All passengers should wear seat belts when using this unit in a moving vehicle.
- If in doubt, please contact your vehicle manufacturer for further advice.

USING THE STAND FOR DESKTOP USE

You can stand the monitor up on a desk or table using the stand on the back.

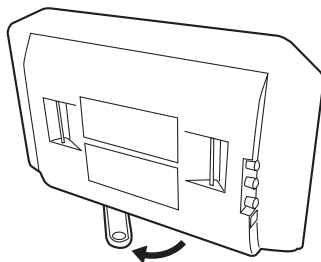

SOUND SYSTEM

Dolby Digital

Dolby Digital is a technology developed by Dolby Laboratories. Soundtracks encoded in Dolby Digital can reproduce from one to 5.1 discrete channels of excellent quality audio.

The unit automatically recognizes the Dolby Digital bitstream and provides a downmix suitable for two-channel listening. An additional Dolby Digital decoder is required for reproduction of the discrete multi-channel soundtracks available on many DVDs.

Manufactured under license from Dolby Laboratories.
'Dolby' and the double-D symbol are trademarks of Dolby Laboratories.



UNIT OPERATION

Turning on the Unit

1. Slide the CHARGE / STANDBY / ON switch on the main unit to the ON, slide the ON / OFF switch on the monitor to the ON.
2. The start-up picture will appear on the screen of the main unit.
3. After use, slide the CHARGE / STANDBY / ON switch on the main unit to STANDBY (power off), slide the ON / OFF switch on the monitor to the OFF.

This owner's manual explains the basic instructions for operating this unit. Some DVDs are produced in a manner that allows specific or limited operation during playback. Therefore, this unit may not respond to all operating commands. THIS IS NOT A DEFECT. Please refer to the instructions

accompanying the specific DVD in question for more information about the options available on that DVD.

"" may appear on the screen during operation. A "" means that the desired operation is not permitted by the unit or disc.

Playing a Disc

1. Slide the CHARGE / STANDBY / ON switch to the ON position. Slide the ON / OFF switch on the monitor to the ON position. See CUSTOMIZING THE FUNCTION SETTINGS before proceeding to step 2.
2. Pull down front panel to open the disc door.
3. Hold the disc by its sides and gently push it onto the spindle, with label side facing toward you until you hear a "click".
4. Gently push the disc door closed. It takes a short while for your unit to load the disc. After loading, for most DVDs, the unit will automatically take you main menu or start playing. If the unit does not automatically start playing the DVD, press the ► PLAY button.

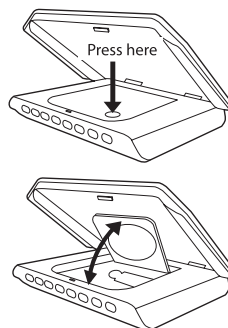

Pausing Playback (Still Mode)

Press the PAUSE button. To resume normal playback, press the ► PLAY button.

Each time you press the PAUSE button, the picture advances one frame.

Stopping Playback

Press the STOP button at the location where you want to interrupt playback. To resume playback at the position where the disc was stopped, press the ► PLAY button.

If you press the STOP button twice, the unit's memory will be cleared and pressing the ► PLAY button will reset the disc to the beginning.

Fast Forward / Fast Reverse

1. Press the SEARCH ►► or ◄◄ SEARCH button when a disc is playing. Each time you press the SEARCH ►► or ◄◄ SEARCH button, the playback speed changes in the following sequence:

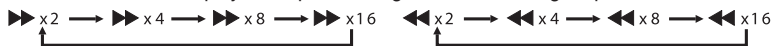

2. Press the ► PLAY button when you reach the desired point to resume normal playback.

Note:

- The DVD player mutes sound and subtitles during reverse and forward scan of DVDs.
- The fast playback speed may differ depending on the disc.

Skip (Forward / Reverse)

- Press the ◄◄ PREV button to go back to current or previous chapters/tracks.
- Press the ►► NEXT button to advance chapters/tracks.
- For audio CDs, use the number buttons on the remote control to jump immediately to the desired track number.

2/4 D 2 Ch Eng

Audio Selection

On some DVDs, the sound is recorded in two or more formats. Follow the directions below to select the preferred language and sound system.

1. While a disc is playing, press the AUDIO button to show the current audio format number.
2. Press the AUDIO button repeatedly to select the desired audio format.

Note:

- If only one audio format is recorded on the DVD, the number does not change.
- Some DVDs allow you to change audio selections using the disc menu only. If this is the case, press the MENU button and choose the appropriate language on the disc menu.
- You can select different audio channels (Stereo, Left or Right) on an Audio CD by pressing the AUDIO button repeatedly.

Subtitle Selection

1. While a DVD is playing, press the SUBTITLE button to display the current language setting, as shown in the example.  1/4 Eng

2. Press the SUBTITLE button repeatedly to select the desired subtitle language. You can turn subtitles off by pressing the SUBTITLE button repeatedly until the "Off" is displayed.

Note:

- Some DVDs are set to display subtitles automatically, and you cannot turn them off even if you set the subtitle function to off.
- During some scenes, the subtitles may not appear immediately after you select your desired scene.
- The number of subtitle languages recorded differs depending on the disc. If only one language is recorded, the language does not change.
- This function can only be used for discs on which subtitles have been recorded in multiple languages.
- Some DVDs allow you to change subtitles using the disc menu only. If this is the case, press the MENU button and choose the appropriate subtitle on the disc menu.

Angle Selection

Some DVDs contain scenes which have been shot from a number of different angles. For these discs, the same scene can be viewed from each of these different angles.

1. While you are playing a DVD with different angles recorded, press the ANGLE button to view the number of current angles available.

2. Press the ANGLE button repeatedly to change the scene to the next recorded angle.

- After approx. two seconds, playback will continue from the new angle you selected.
- If no button is pressed within 10 seconds, playback continues without changing the current angle.

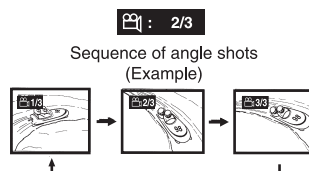

Note:

- This function can only be used for discs on which scenes shot from multiple angles have been recorded.
- If only one angle is recorded, "ANGLE 1/1" is displayed.

Display Function

While the disc is playing, press the DISPLAY button repeatedly to display information on operation status.

Elapsed Time: Elapsed time from the beginning of the title which is currently playing.

Remain Time: Remaining time of the title which is currently playing.



Adjust the LCD Screen

You can adjust Brightness, Contrast or Color of the LCD screen.

1. Press the VIDEO MODE button.
2. Press the ▲ / ▼ button to select Brightness, Contrast, Color or View Mode.
3. Then press the ◀ / ▶ button to change the setting (For View Mode, press the ENTER button to change the setting).
4. Press the VIDEO MODE button to exit the menu.

Note:

For the monitor, you can adjust the LCD screen by the BRIGHTNESS control, COLOR control and Screen (WIDE / NORMAL) switch on the monitor.

LOCATING A DESIRED SECTION

Locating a Specific Title

If a DVD contains title numbers, you can locate a specific title by directly selecting its title number.

1. Press the GOTO button.
2. Press the corresponding number button(s) for the title you want.
3. Press the ENTER button to confirm. Playback starts from the selected section.

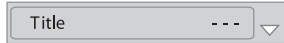

Note:

- If the title numbers you entered is not permitted by the DVD, after you press the ENTER button, it will restore to - - -. You should re-enter correct numbers.
- Some discs may not respond to this process.
- This method of locating a title is available only on a DVD that contains title numbers.

Locating a Specific Chapter

If you know the chapter number for the chapter that you want to play, you can locate it by directly selecting that number.

1. Press the GOTO button.
2. Press ▲ or ▼ button to display Chapter and press the corresponding number button(s) for the chapter you want.
3. Press the ENTER button to confirm. Playback starts from the selected section.

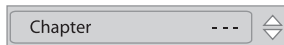

Note:

- If the chapter numbers you entered is not permitted by the DVD, after you press the ENTER button, it will restore to - - -. You should re-enter correct numbers.
- Some discs may not respond to this process.
- This method of locating a chapter is available only on a DVD that contains chapter numbers.

Locating a Specific Time

You can move to a specific location by entering its corresponding time (hours, minutes, seconds).

1. Press the GOTO button.
2. Press ▲ or ▼ button to display Time and press the corresponding number buttons for the setting point you want.
3. Press the ENTER button to confirm. Playback starts from the selected section.



Note:

- If the time numbers you entered is not permitted by the DVD, after you press the ENTER button, it will restore to - - : - - : - -. You should re-enter correct numbers.
- Some discs may not respond to this process.
- Some scenes may not be located as precisely as you specified.
- This method for accessing specific locations is available only within the current title of the DVD.

Playing Titles/Chapters in a Favorite Order

You can combine your favorite titles/chapters and play them in the order you determine.

1. When a DVD is stopped, press the MEMORY button and the following display appears.
2. Select the items in the order you want by pressing the number buttons. Each time you press the Cursor buttons (▼, ▲, ◀, ▶), the space is highlighted. Highlight where you want to enter, then press the corresponding number buttons.
3. Press the Cursor buttons (▼, ▲, ◀, ▶) to move the highlighted bar to Play Memory, then press the ENTER button. The DVD player starts memory playback.
4. To resume normal playback from memory playback
 - 1). Press the MEMORY button in stop mode.
 - 2). Press the Cursor buttons (▼, ▲, ◀, ▶) to move the highlighted bar to "Clear All", then press the ENTER button. All the input programs will be cleared.
 - 3). Press the ► PLAY button to resume normal playback.

Memory Input	Title/Chapter
Play Memory	1 - - - -
Clear All	2 - - - -
	3 - - - - ▼

Title number Chapter number

Note:

- If the title or chapter numbers you entered is not permitted by the DVD, after you press the ENTER button, it will restore to - - -. You should re-enter correct numbers.
- Some discs may not permit memory playback operation.
- If you select repeat during memory playback, the DVD player repeats the current memory playback.
- If you press the MEMORY button while the display appears on the TV screen, the display disappears.
- The programmed selections will be cleared when you open the disc tray or turn off the DVD player.

REPEAT PLAYBACK

You can play a specific title or chapter repeatedly. (Title repeat, chapter repeat, A-B repeat)

Repeating a Chapter

1. While the DVD is playing, press the REPEAT DISC button until the "Repeat Chapter" indicator displays on the screen. The current chapter is played repeatedly.

Repeating a Title

2. While the DVD is playing, press the REPEAT DISC button until the "Repeat Title" indicator displays on the screen. The current title is played repeatedly.

To Resume Normal Playback

3. While the DVD is playing, press the REPEAT DISC button until the "Repeat Off" indicator displays on the screen.

You can play a single track or the whole disc repeatedly.

Repeating a Single Track

1. While the CD disc is playing, press the REPEAT DISC button until the "Repeat single" indicator displays on the screen. The current track is played repeatedly.

Repeating a Whole Disc

2. While the CD disc is playing, press the REPEAT DISC button until the "Repeat all" indicator

displays on the screen. The whole disc is played repeatedly.

To Resume Normal Playback

3. Press the REPEAT DISC button until the "Repeat Off" indicator displays on the screen.

Repeating a Specific Section

You can play a specific section repeatedly.

1. While the disc is playing, press the REPEAT A-B button at the beginning of the section ("Rep A-" is displayed) you want to play repeatedly.
2. Press the REPEAT A-B button again at the end of the section ("Rep A-B" is displayed).
3. The Unit will immediately begin replaying your selection.

To Resume Normal Playback

4. While the disc is playing, press the REPEAT A-B button until the "RepA-B Off" indicator displays on the screen.

Note:

- Some discs may not permit A-B repeat operation.
- You cannot set the A-B repeat function for a segment that includes multiple camera angles.
- You can specify a segment only within the current title or track.
- There may be a slight difference between point A and the location where playback actually resumes depending on the disc.

VIEWING JPG FILES

This unit can play JPG files recorded on a CD-R or CD-ROM disc (CD-RW is not recommendable).

Viewing JPG Files

1. Open the disc door.
2. Hold a JPG file disc by its edge and gently push it onto the spindle with the label side facing up until you hear a "click".
3. Close the disc door. A list of folders/files will appear on the screen.
4. Press the ▲ or ▼ button to select your desired file. The selected picture will appear at the lower right corner. Press the ► PLAY button to start playback. Press the ■ STOP button to display a folder list.

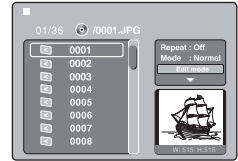

Note:

- You can press the || PAUSE button to interrupt playback. Press the ► PLAY button to resume playback.
- You can press the ■ STOP button to quit playback.
- You can press the ◀◀ PREV or ▶▶ NEXT button to change the picture.
- You can press the ANGLE button to rotate direction of the picture by 90°.
- Some discs may not permit this operation.

PLAY MODES FOR CD OR JPEG DISC

When playing CD / JPG discs, you can modify the Play Modes through the Toolkit which appears on the picture on the screen. Press the ◀/▶ button to navigate between the windows and the ▲/▼ button to select files/tracks or play mode items. Then press the ENTER button.

1. In Stop mode, press the Cursor buttons (▼, ▲, ◀, ▶) to select "Edit mode" then press the ENTER button.
2. Use the Cursor buttons (▼, ▲, ◀, ▶) to select tracks/files shown on the left hand side of the window. Press the ENTER button to confirm the selected tracks/files. "✓" will appear in front of the selected tracks/files.
3. Select "Add to program", then press the ENTER button. "✓" will disappear from the screen. It means that the tracks/files you have selected are added into the "Program view".
4. Select "Program view" to view programmed files. To add more files by "Browser view" follow above steps.
5. Press the ► PLAY button to start the program playback.

The Toolkit has the following play mode items:

- Repeat (Off / Single / All):
Off: Resumes normal playback.
Single: Repeats the current track/file.
All: Repeats all files on the current folder or all tracks on the disc.
- Mode (Normal / Shuffle / Music intro):
Normal: Resumes normal playback.
Shuffle: Playbacks track/file in random order.
Music intro (for Audio CD only): Only plays back the first 10 seconds of all the tracks on the current folder/ disc.
- Edit mode: Program operation works only when "Edit mode" is selected.
- Program view: To view tracks/files in the "Program view" list. It is disabled when the "Program view" list is empty.
- Add to program: Add files/tracks to the "Program view" list. It is disabled if the "Edit mode" is not selected.
- Browser view: To view files/tracks in the original view list.
- Clear program: Delete the files/tracks in the "Program view" list.
Select a file/track or more you want to delete in complete stop mode (press the ■ STOP button twice). "✓" will appear beside the deleted file/track. Select "Clear program" and then press the ENTER button. It is disabled if the "Edit mode" is not selected.

Note: The program will be deleted if the disc door is opened, or selected files are deleted by selecting "Clear program".

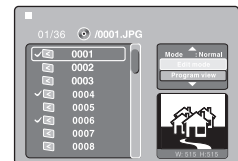

CUSTOMIZING THE FUNCTION SETTINGS

Language

OSD Language

1. Press the SETUP button in stop mode.
2. Press the ► button to select OSD Language.
3. Press the ENTER button, then the ▲ / ▼ button to shift and change the Language.
4. Press the ENTER button.
5. Press the SETUP button or RETURN button to exit the menu.

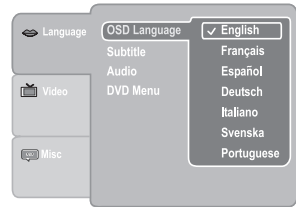

Subtitle

1. Press the SETUP button in stop mode.
2. Press the ► button, then the ▲ / ▼ button to select Subtitle.
3. Press the ENTER button, then the ▲ / ▼ button to shift and change the Language.
4. Press the ENTER button.
5. Press the SETUP button or RETURN button to exit the menu.

Notes:

- Some DVDs may be set to display subtitles in a different language other than the ones you selected. A prior subtitle language may be programmed on the disc.
- Some DVDs allow you to change subtitle selections using the disc menu only. If this is the case, press the MENU button and choose the appropriate subtitle language from the selection on the disc menu.

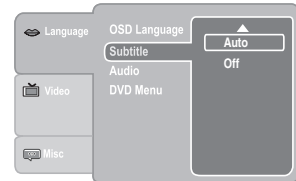
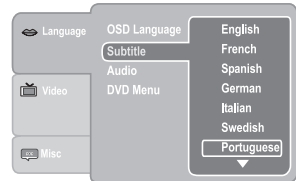

Audio

1. Press the SETUP button in stop mode.
2. Press the ► button, then the ▲ / ▼ button to select Audio.
3. Press the ENTER button, then the ▲ / ▼ button until your preferred Audio is displayed.
4. Press the ENTER button.
5. Press the SETUP button or RETURN button to exit the menu.

Note:

- Some DVDs may not be played in the language you selected. A prior language may be programmed on the disc.

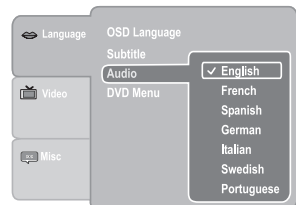

DVD Menu

1. Press the SETUP button in stop mode.
2. Press the ► button, then the ▲ / ▼ button to select DVD Menu.
3. Press the ENTER button, then the ▲ / ▼ button until your preferred DVD Menu language is displayed.
4. Press the ENTER button.
5. Press the SETUP button or RETURN button to exit the menu.

Note:

- Some DVDs may not include your pre-selected language. In this case, the DVD player automatically displays disc menus consistent with the disc's initial language setting.

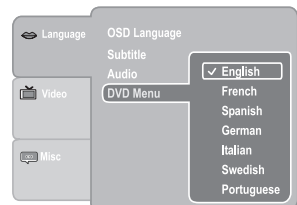

CUSTOMIZING THE FUNCTION SETTINGS

VIDEO

Aspect Ratio

1. Press the SETUP button in stop mode.
2. Press the ▲ / ▼ button to select Video.
3. Press the ► button, then the ▲ / ▼ button to select Aspect Ratio.
4. Press the ENTER button, then the ▲ / ▼ button to shift and change the aspect ratio.
5. Press the ENTER button.
6. Press the SETUP button or RETURN button to exit the menu.

Notes:

- The displayable picture size is preset on the DVD. Therefore, the playback picture of some DVDs may not conform to the picture size you select.
- When you play DVDs recorded in the 4:3 picture size only, the playback picture always appears in the 4:3 picture size regardless of the Aspect Ratio setting.
- Select 16:9 to conform to the LCD screen on the unit. Always be sure that your Aspect Ratio conforms to the actual TV in use if you connect the unit to a TV.

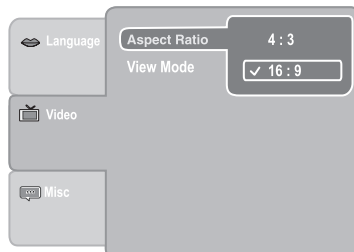

View Mode

1. Press the SETUP button in stop mode.
2. Press the ▲ / ▼ button to select Video.
3. Press the ► button, then the ▲ / ▼ button to select View Mode.
4. Press the ENTER button, then the ▲ / ▼ button to shift and change the View Mode.
5. Press the ENTER button.
6. Press the SETUP button or RETURN button to exit the menu.

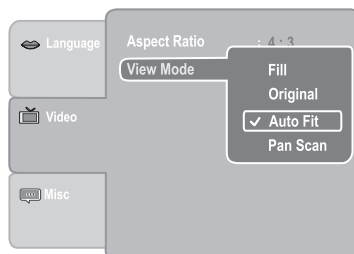

Fill	Fill the screen with decoded image.
Original	Display image as its original size.
Auto Fit	Automatically fit the decoded image on screen without distortion. Black bars will be present on top/bottom or left/right of screen.
Pan Scan	Select when a standard 4:3 TV is connected. Displays pictures cropped to fill your TV screen. Sides of the picture are cut off.

Note:

- Depending on the DVD, you may not be able to view the mode as selected.

CUSTOMIZING THE FUNCTION SETTINGS

MISC

Use Default Settings

1. Press the SETUP button in stop mode.
2. Press the ▲ / ▼ button to select Misc.
3. Press the ► button, then press the ▲ / ▼ button to select "Use Default Settings" dialogue box.
4. Press the ENTER button, then press the ◀ / ▶ button to select "Yes". Press the ENTER button and the original setting will be restored. The unit will exit setting menu automatically and re-load the disc in the disc tray.

Note: It will take 3-5 seconds to reset the DVD player to the factory default.

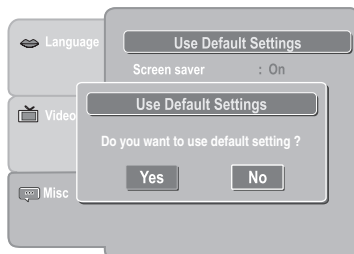

Screen Saver

1. Press the SETUP button in stop mode.
2. Press the ▲ / ▼ button to select Misc.
3. Press the ► button, then press the ▲ / ▼ button to select Screen Saver.
4. Press the ENTER button, then press the ▲ / ▼ button to change the On/Off mode.
5. Press the ENTER button.
6. Press the SETUP button or RETURN button to exit the menu.

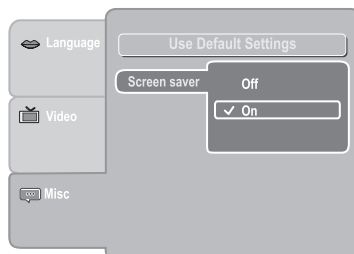

MAINTENANCE

Cleaning the Disc

A defective or soiled disc inserted into the unit can cause sound to drop out during playback. Handle the disc by holding its inner and outer edges.

- Do NOT touch the surface of the unlabeled side of the disc.
- Do NOT stick paper or tape on the surface.
- Do NOT expose the disc to direct sunlight or excessive heat.
- Clean the disc before playback. Wipe the disc from the center outward with a cleaning cloth.
- NEVER use solvents such as benzine or alcohol to clean the disc.
- Do NOT use irregular shaped discs (example: heart shaped, octagonal, etc.). They may cause malfunctions.



Cleaning the Unit

- Be sure to turn the unit off and disconnect the car power adapter before maintaining the unit.
- Wipe the unit with a dry soft cloth. If the surfaces are extremely dirty, wipe clean with a cloth that has been dipped in a weak soap-and-water solution and wrung out thoroughly. Then wipe with a dry cloth.
- Never use alcohol, benzine, thinner, cleaning fluid or other chemicals. Do NOT use compressed air to remove dust.

Important Note

- Before transporting the unit, remove any disc from the disc compartment.

TROUBLESHOOTING GUIDE

SYMPTOM	CAUSE (AND REMEDY)
No power.	<ul style="list-style-type: none">• Ensure the AC power adapter or car power adapter is connected.• Make sure that the unit is turned on.
The remote control does not function.	<ul style="list-style-type: none">• Remove any obstacles between the remote and the unit.• Use the remote near the unit.• Point the remote at the remote sensor on the unit.• Replace the battery in the remote with new one.
Very little or no sound is coming from a DVD.	<ul style="list-style-type: none">• Make sure that you select ON mode.• Make sure the unit is not paused. Press the ► PLAY button.• Make sure the unit is not in fast-forward or fast-reverse mode. Press the ► PLAY button.• Make sure the AUDIO/VIDEO input/output connections are correct.• The DTS DVD cannot be decoded to have speaker output.• The unit has overheated. Shut it off for 30 minutes to allow it to cool down.• The volume control is located on the side of the unit - please try adjusting this.
No picture.	<ul style="list-style-type: none">• The region number of the disc doesn't match the region number of this unit. 
The picture is not clear.	<ul style="list-style-type: none">• The DVD is dirty. Gently clean the disc.• The disc is scratched.• Please adjust the LCD's brightness, contrast and color using the VIDEO MODE button on the remote control.
Loud hum or noise is heard.	<ul style="list-style-type: none">• The plugs and jacks are dirty. Wipe them with a cloth slightly moistened with alcohol.• Clean the disc.
The disc does not play.	<ul style="list-style-type: none">• There is no disc inside the unit ("No Disc" appears on the screen).• Insert the disc correctly with the graphics facing up.• Clean the disc.• A non-NTSC disc has been inserted, or the disc region number does not match the region number of the unit.• Condensation may have formed inside the unit due to a sudden change in temperature. Wait about an hour for it to clear and try again.

Specifications and external appearance are subject to change without notice.

Need more help?
Please visit online help at
<http://www.1800customersupport.com/RCA>

